

# Linear Voltage Regulator - Bias Rail, Low Noise, Very Low Dropout, Programmable Soft-Start 3 A

## NCV59745

### Description

The NCV59745 is very low dropout low noise dual-rail voltage regulator that is capable of providing an output current in excess of 3.0 A with a dropout voltage of 115 mV typ. at full load current. This series contains fixed output voltage devices. The high output current capability with high accuracy, broad bandwidth high PSRR and low noise makes this VLDOs ideal for powering noise sensitive high speed communication devices, high end FPGAs and microprocessors.

The NCV59745 is offered in QFNW20 4.0 mm x 4.0 mm package.

### Features

- Output Current in Excess of 3.0 A
- 0.25% Typical Accuracy Over Line and Load
- $V_{IN}$  Range: 0.8 V to 5.5 V
- $V_{BIAS}$  Range: 2.2 V to 5.5 V
- Output Voltage Range: 0.8 V to 3.6 V
- Dropout Voltage: 105 mV typ. at 3 A
- Programmable Soft Start
- Open Drain Power Good Output
- Low Noise, 6  $\mu V_{RMS}$  Typically
- Excellent Transient Response
- NCV Prefix for Automotive and Other Applications Requiring Unique Site and Control Change Requirements; AEC-Q100 Qualified and PPAP Capable
- These are Pb-Free Devices, Wetable Flank for AOI

### Applications

- High Speed Analog VCO, DAC, ADC
- FPGAs, DSPs, SerDes
- Imaging Sensors and ASICs
- Automotive, Telecom and Industrial Equipment Point of Load Regulation

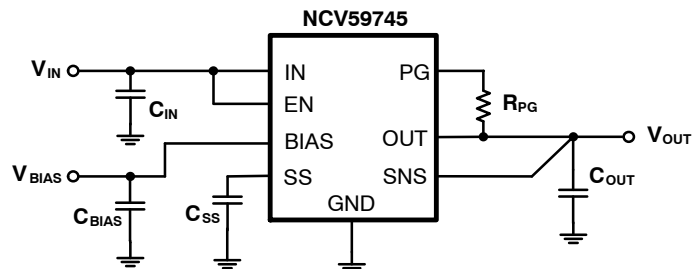
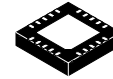

Figure 1. Typical Application Schematic



ON Semiconductor®

[www.onsemi.com](http://www.onsemi.com)



QFNW20  
MW SUFFIX  
CASE 484AP

### MARKING DIAGRAM

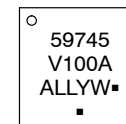

- A = Assembly Location
- LL = Wafer Lot
- Y = Year
- W = Work Week
- = Pb-Free Package

(Note: Microdot may be in either location)

### PIN CONNECTIONS

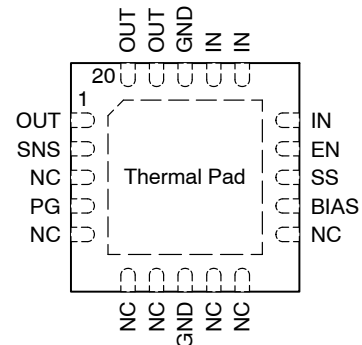

### ORDERING INFORMATION

See detailed ordering, marking and shipping information on page 10 of this data sheet.

# NCV59745

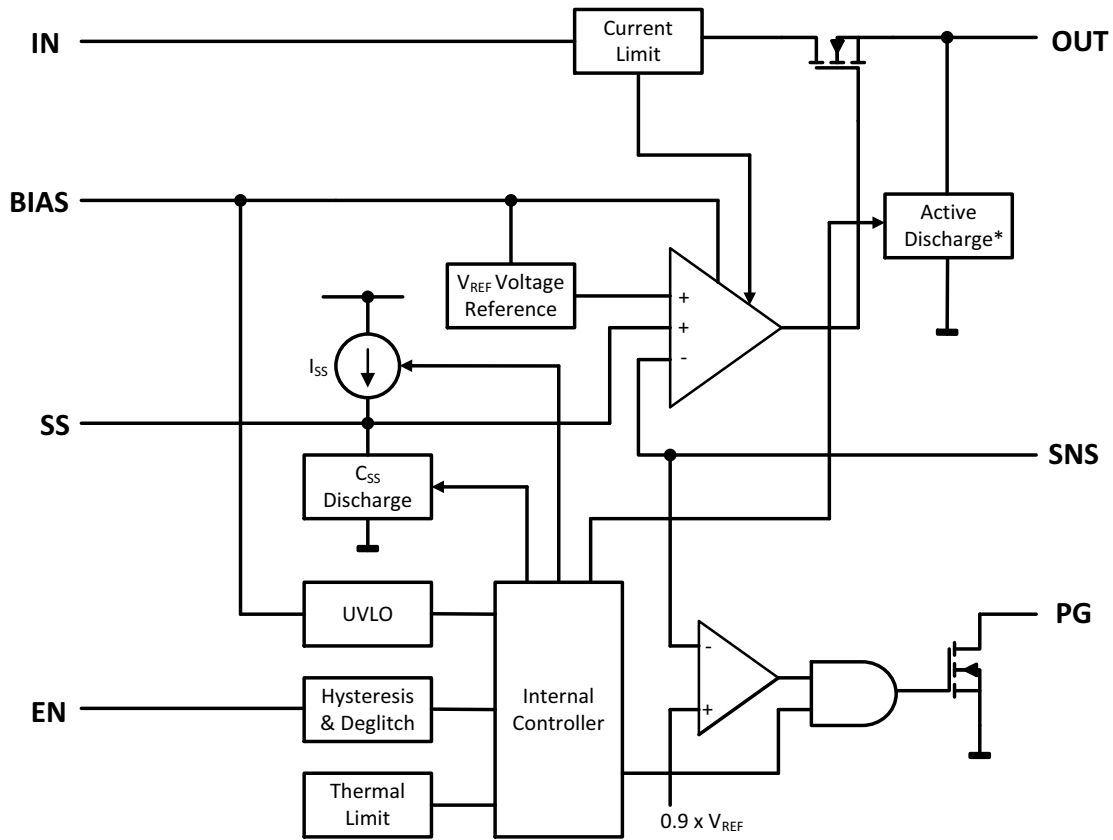

\*Active output discharge function is present only in NCV59745A option devices.

**Figure 2. Simplified Schematic Block Diagram**

**Table 1. PIN FUNCTION DESCRIPTION**

Name	QFNW20	Description
IN	15–17	Unregulated voltage input to the device.
EN	14	Enable pin. Driving this pin high enables the regulator. Driving this pin low puts the regulator into shut-down mode. This pin must not be left floating.
SS	13	Soft-Start pin. A capacitor connected on this pin to ground sets the Soft – Start time.
BIAS	12	Bias input voltage for error amplifier, reference, and internal control circuits.
PG	4	Power-Good (PG) is an open-drain, active-high output that indicates the status of $V_{OUT}$ . When $V_{OUT}$ exceeds the PG trip threshold, the PG pin goes into a high-impedance state. When $V_{OUT}$ is below this threshold the pin is driven to a low-impedance state. A pull-up resistor from 10 k $\Omega$ to 100 k $\Omega$ should be connected from this pin to a supply up to 5.5 V. The supply can be higher than the input voltage. Alternatively, the PG pin can be left floating if output monitoring is not necessary.
SNS	2	Output voltage sense input pin. This pin must not be left floating.
OUT	1, 19, 20	Regulated output voltage. It is recommended that the output capacitor $\geq 10 \mu\text{F}$ (effective value).
NC	3, 5–7, 9–11	No connection. Each one pin is “true NC” and can be left floating or connected to GND to allow better thermal contact to the PCB top-side plane.
GND	8, 18	Ground pins. Both these pins must be connected to ground.
PAD/TAB		Should be soldered to the ground plane for increased thermal performance

**Table 2. ABSOLUTE MAXIMUM RATINGS**

Parameter	Symbol	Value	Unit
Input Voltage Range	$V_{IN}$	-0.3 to +6	V
Bias Voltage Range	$V_{BIAS}$	-0.3 to +6	V
Enable Voltage Range	$V_{EN}$	-0.3 to +6	V
Power-Good Voltage Range	$V_{PG}$	-0.3 to +6	V
PG Sink Current	$I_{PG}$	0 to +1.5	mA
SS Pin Voltage Range	$V_{SS}$	-0.3 to $(V_{BIAS} + 0.3) \leq 6$	V
Output Sense Pin Voltage Range	$V_{SNS}$	-0.3 to +6	V
Output Voltage Range	$V_{OUT}$	-0.3 to $(V_{IN} + 0.3) \leq 6$	V
Maximum Output Current	$I_{OUT}$	Internally Limited	
Output Short Circuit Duration		Indefinite	
Continuous Total Power Dissipation	$P_D$	See Thermal Characteristics Table and Formula	
Maximum Junction Temperature	$T_{JMAX}$	+150	°C
Storage Junction Temperature Range	$T_{STG}$	-55 to +150	°C
ESD Capability, Human Body Model (Note 2)	$ESD_{HBM}$	2000	V
ESD Capability, Charged Device Model (Note 2)	$ESD_{CDM}$	1000	V

Stresses exceeding those listed in the Maximum Ratings table may damage the device. If any of these limits are exceeded, device functionality should not be assumed, damage may occur and reliability may be affected.

1. Refer to ELECTRICAL CHARACTERISTICS and APPLICATION INFORMATION for Safe Operating Area.
2. This device series incorporates ESD protection and is tested by the following methods:  
 ESD Human Body Model tested per AEC-Q100-002  
 ESD Charged Device Model tested per AEC-Q100-011  
 Latch-up Current Maximum Rating  $\pm 100$  mA per AEC-Q100-004.

**Table 3. THERMAL CHARACTERISTICS**

Rating	Symbol	Value	Unit
Thermal Characteristics, QFNW20, 4.0x4.0, 0.5P package			
Thermal Resistance, Junction-to-Ambient (Note 5)	$R_{\theta JA}$	40	°C/W
Thermal Resistance, Junction-to-Board (Note 6)	$R_{\theta JB}$	3.6	°C/W
Thermal Resistance, Junction-to-Case (top)	$R_{\theta JC(top)}$	27	°C/W
Thermal Resistance, Junction-to-Case (bottom) (Note 7)	$R_{\theta JC(bot)}$	3.6	°C/W
Characterisation Parameter, Junction-to-Top	$\Psi_{JT}$	1.0	°C/W
Characterisation Parameter, Junction-to-Board	$\Psi_{JB}$	3.5	°C/W

3. Refer to ELECTRICAL CHARACTERISTICS and APPLICATION INFORMATION for Safe Operating Area.
4. Thermal data are derived by thermal simulations based on methodology specified in the JEDEC JESD51 series standards. The following assumptions are used in the simulations:  
 These data were generated with only a single device at the center of a high-K (2s2p) board with 3 in x 3 in copper area which follows the JEDEC51.7 guidelines. Top and Bottom layer 2 oz. copper, inner planes 1 oz. copper.  
 The exposed pad is connected to the PCB ground inner layer through a 3 x 3 thermal via array. Vias are 0.3 mm diameter, plated.
5. The junction-to-ambient thermal resistance under natural convection is obtained in a simulation on a high-K board, following the JEDEC51.7 guidelines with assumptions as above, in an environment described in JESD51-2a.
6. The junction-to-board thermal resistance is simulated in an environment with a ring cold plate fixture to control the PCB temperature, as described in JESD51-8.
7. The junction-to-case (bottom) thermal resistance is obtained by simulating a cold plate test on the IC exposed pad. Test description can be found in the ANSI SEMI standard G30-88.

**Table 4. RECOMMENDED OPERATING CONDITIONS** (Note 8)

Rating	Symbol	Min	Max	Unit
Input Voltage	$V_{IN}$	$V_{OUT} + V_{DO}$	5.5	V
Bias Voltage	$V_{BIAS}$	$V_{OUT} + 1.6$	5.5	V
Junction Temperature	$T_J$	-40	125	°C

Functional operation above the stresses listed in the Recommended Operating Ranges is not implied. Extended exposure to stresses beyond the Recommended Operating Ranges limits may affect device reliability.

8. Refer to ELECTRICAL CHARACTERISTICS and APPLICATION INFORMATION for Safe Operating Area.

# NCV59745

**Table 5. ELECTRICAL CHARACTERISTICS** (At  $V_{EN} = 1.1\text{ V}$ ,  $V_{IN} = V_{OUT(NOM)} + 0.25\text{ V}$ ,  $C_{BIAS} = 1\text{ }\mu\text{F}$ ,  $C_{IN} = 4.7\text{ }\mu\text{F}$ ,  $C_{OUT} = 10\text{ }\mu\text{F}$ ,  $I_{OUT} = 50\text{ mA}$ ,  $V_{BIAS} = 5.0\text{ V}$ ,  $T_J = -40^\circ\text{C}$  to  $+125^\circ\text{C}$ , unless otherwise noted. Typical values are at  $T_J = +25^\circ\text{C}$ .)

Symbol	Parameter	Test Conditions	Min	Typ	Max	Unit
$V_{IN}$	Input voltage range		$V_{OUT} + V_{DO}$		5.5	V
$V_{BIAS}$	Bias pin voltage range		$V_{OUT} + 1.4$		5.5	V
UVLO	Undervoltage Lock-out	$V_{BIAS}$ Rising Hysteresis	1.2 –	1.5 0.45	2.0 –	V
$V_{OUT}$	Accuracy	$2.4\text{ V} \leq V_{BIAS} \leq 5.25\text{ V}$ , $V_{OUT} + 1.6\text{ V} \leq V_{BIAS}$ $50\text{ mA} \leq I_{OUT} \leq 3.0\text{ A}$	–1.0	$\pm 0.3$	+1.0	%
$V_{OUT}/V_{IN}$	Line regulation	$V_{OUT(NOM)} + 0.25 \leq V_{IN} \leq 5.5\text{ V}$		0.0006		%/V
$V_{OUT}/I_{OUT}$	Load regulation	$0\text{ mA} \leq I_{OUT} \leq 50\text{ mA}$		0.005		%/mA
		$50\text{ mA} \leq I_{OUT} \leq 3.0\text{ A}$		0.01		%/A
$V_{DO}$	$V_{IN}$ dropout voltage (Note 9)	$I_{OUT} = 3.0\text{ A}$ , $V_{BIAS} - V_{OUT(NOM)} = 1.6\text{ V}$		105	195	mV
	$V_{BIAS}$ dropout voltage (Note 9)	$I_{OUT} = 3.0\text{ A}$ , $V_{IN} = V_{BIAS}$		1.2	1.4	V
$I_{CL}$	Current limit	$V_{OUT} = 80\% \times V_{OUT(NOM)}$	3.5	4.3	7	A
$I_{BIAS}$	Bias pin current	$0\text{ mA} \leq I_{OUT} \leq 3.0\text{ A}$		1.3	2	mA
$I_{BSHDN}$	$V_{BIAS}$ shutdown current	$V_{EN} \leq 0.4\text{ V}$		1	15	$\mu\text{A}$
$I_{INSHDN}$	$V_{IN}$ shutdown current	$V_{EN} \leq 0.4\text{ V}$ , $V_{OUT} = 0\text{ V}$		1	15	$\mu\text{A}$
$I_{SNS}$	Sense pin current	$0\text{ mA} \leq I_{OUT} \leq 3.0\text{ A}$	–250	95	250	nA
PSRR	Power-supply rejection ( $V_{IN}$ to $V_{OUT}$ )	1 kHz, $I_{OUT} = 2\text{ A}$ , $V_{IN} = 1.25\text{ V}$ , $V_{OUT} = 1.0\text{ V}$		75		dB
		3 MHz, $I_{OUT} = 2\text{ A}$ , $V_{IN} = 1.25\text{ V}$ , $V_{OUT} = 1.0\text{ V}$		18		
	Power-supply rejection ( $V_{BIAS}$ to $V_{OUT}$ )	1 kHz, $I_{OUT} = 2\text{ A}$ , $V_{IN} = 1.25\text{ V}$ , $V_{OUT} = 1.0\text{ V}$		75		dB
		3 MHz, $I_{OUT} = 2\text{ A}$ , $V_{IN} = 1.25\text{ V}$ , $V_{OUT} = 1.0\text{ V}$		18		
Noise	Output noise voltage	10 Hz to 100 kHz, $I_{OUT} = 2\text{ A}$		6		$\mu\text{Vrms}$
$t_{STRT}$	Minimum startup time	$I_{OUT} = 3\text{ A}$ , $C_{SS} = \text{open}$ (Note 10)		350		$\mu\text{s}$
$I_{SS}$	Soft-start charging current	$V_{SS} = 0.4\text{ V}$		$6.2 \times \frac{V_{OUT(NOM)}}{0.8\text{ V}}$		$\mu\text{A}$
$V_{EN, HI}$	Enable input high level		1.1		5.5	V
$V_{EN, LO}$	Enable input low level		0		0.4	V
$V_{EN, HYS}$	Enable pin hysteresis			100		mV
$V_{EN, DG}$	Enable pin deglitch time			20		$\mu\text{s}$
$I_{EN}$	Enable pin current	$V_{EN} = 5\text{ V}$		0.3	1	$\mu\text{A}$
$V_{IT-}$	PG trip threshold	$V_{OUT}$ decreasing	82	88	93	% $V_{OUT}$
$V_{IT+}$	PG trip threshold	$V_{OUT}$ increasing	83	91	96	% $V_{OUT}$
$V_{HYS}$	PG trip hysteresis			3		% $V_{OUT}$
$V_{PG, LO}$	PG output low voltage	$I_{PG} = 1\text{ mA}$ (sinking), $V_{OUT} < V_{IT}$			0.3	V
$I_{PG, LKG}$	PG leakage current	$V_{PG} = 5.25\text{ V}$ , $V_{OUT} > V_{IT}$		0.03	1	$\mu\text{A}$
$R_{AD}$	Output Active Discharge Resistance (NCV59745A option only)	$V_{BIAS} = 5.0\text{ V}$ , $V_{EN} = 0\text{ V}$ , $V_{IN} = 1.25\text{ V}$ , $V_{OUT} = 1.0\text{ V}$		600		$\Omega$
TSD	Thermal shutdown temperature	Shutdown, temperature increasing Reset, temperature decreasing		+165 +140		$^\circ\text{C}$

Product parametric performance is indicated in the Electrical Characteristics for the listed test conditions, unless otherwise noted. Product performance may not be indicated by the Electrical Characteristics if operated under different conditions.

9. Dropout is defined as the voltage from the input to  $V_{OUT}$  when  $V_{OUT}$  is 3% below nominal.

10. Time from EN rising edge to 98% of  $V_{OUT(NOM)}$

TYPICAL CHARACTERISTICS

At  $T_J = +25^\circ\text{C}$ ,  $V_{IN} = V_{OUT(NOM)} + 0.25\text{ V}$ ,  $V_{BIAS} = V_{OUT(NOM)} + 1.6\text{ V}$ ,  $V_{EN} = 1.1\text{ V}$ ,  $V_{OUT(NOM)} = 1.0\text{ V}$ ,  $C_{IN} = 10\text{ }\mu\text{F}$ ,  $C_{BIAS} = 1\text{ }\mu\text{F}$ , and  $C_{OUT} = 10\text{ }\mu\text{F}$  (effective capacitance value), unless otherwise noted.

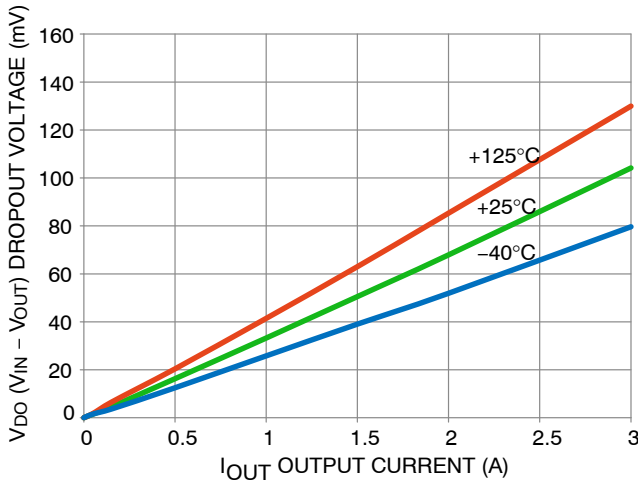

Figure 3.  $V_{IN}$  Dropout Voltage vs.  $I_{OUT}$  and Temperature  $T_J$

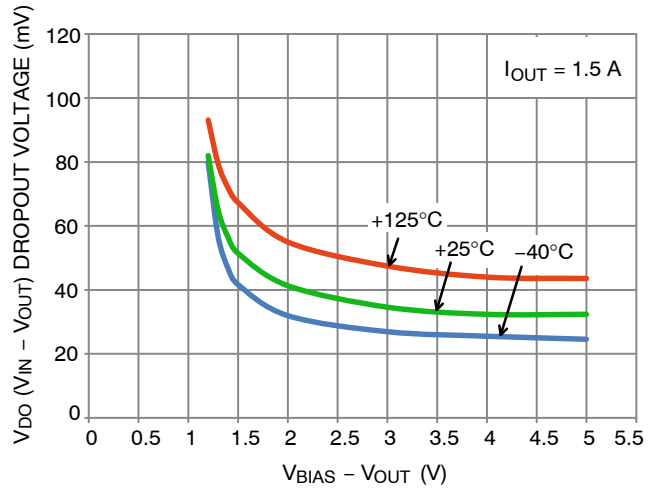

Figure 4.  $V_{IN}$  Dropout Voltage vs.  $(V_{BIAS} - V_{OUT})$  and Temperature  $T_J$

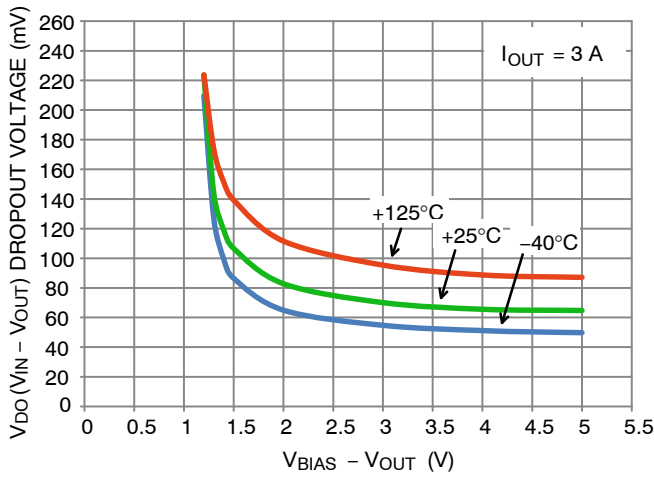

Figure 5.  $V_{IN}$  Dropout Voltage vs.  $(V_{BIAS} - V_{OUT})$  and Temperature  $T_J$

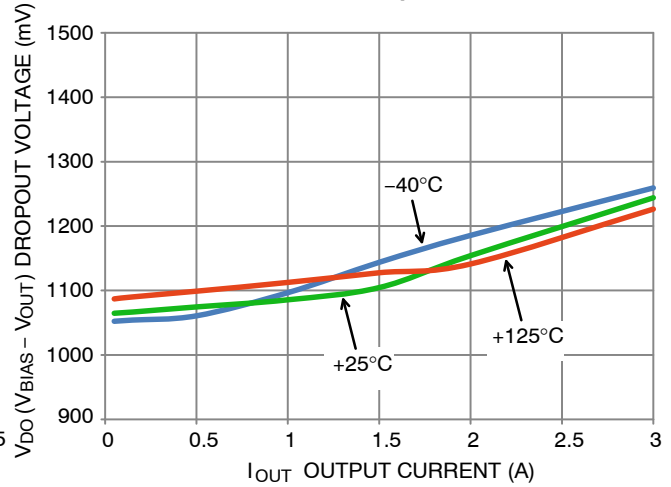

Figure 6.  $V_{BIAS}$  Dropout Voltage vs.  $I_{OUT}$  and Temperature  $T_J$

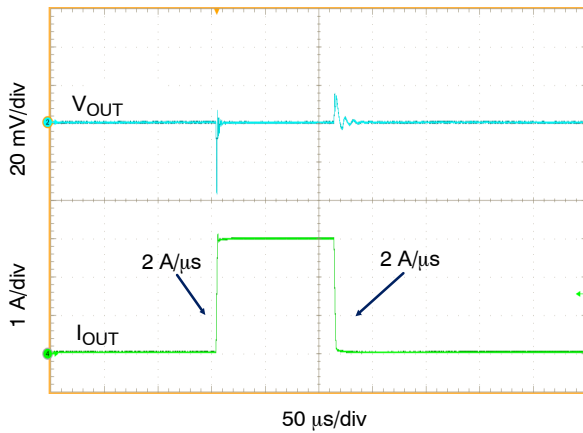

Figure 7. Load Transient Response,  $I_{OUT} = 10\text{ mA}$  to  $3\text{ A}$ ,  $C_{OUT} = 10\text{ }\mu\text{F MLCC}$

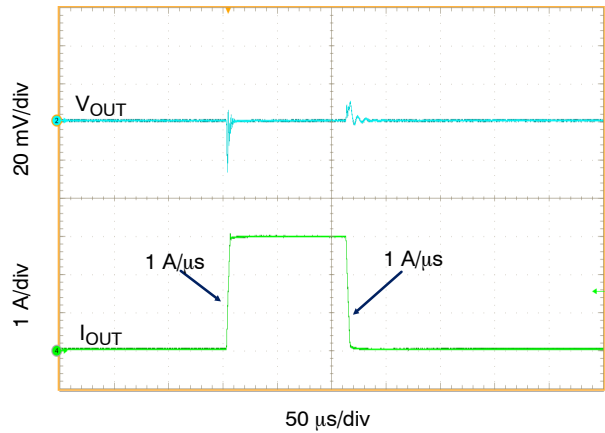

Figure 8. Load Transient Response,  $I_{OUT} = 10\text{ mA}$  to  $3\text{ A}$ ,  $C_{OUT} = 10\text{ }\mu\text{F MLCC}$

TYPICAL CHARACTERISTICS

At  $T_J = +25^\circ\text{C}$ ,  $V_{IN} = V_{OUT(NOM)} + 0.25\text{ V}$ ,  $V_{BIAS} = V_{OUT(NOM)} + 1.6\text{ V}$ ,  $V_{EN} = 1.1\text{ V}$ ,  $V_{OUT(NOM)} = 1.0\text{ V}$ ,  $C_{IN} = 10\text{ }\mu\text{F}$ ,  $C_{BIAS} = 1\text{ }\mu\text{F}$ , and  $C_{OUT} = 10\text{ }\mu\text{F}$  (effective capacitance value), unless otherwise noted.

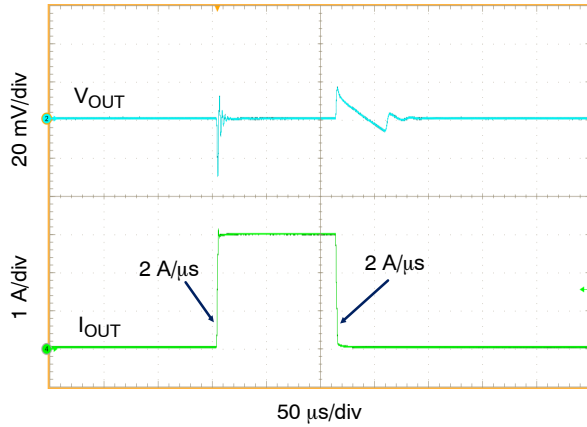

Figure 9. Load Transient Response,  $I_{OUT} = 10\text{ mA to }3\text{ A}$ ,  $C_{OUT} = 47\text{ }\mu\text{F MLCC}$

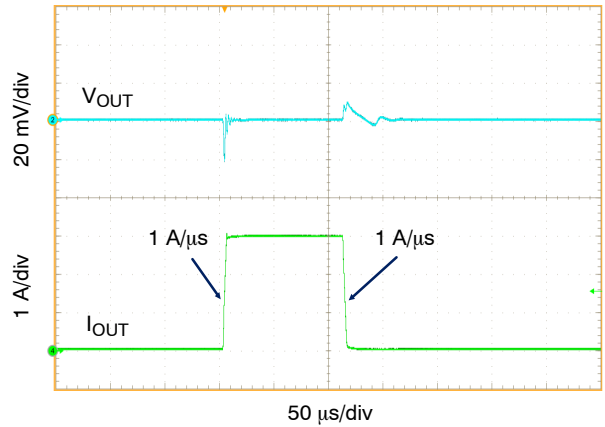

Figure 10. Load Transient Response,  $I_{OUT} = 10\text{ mA to }3\text{ A}$ ,  $C_{OUT} = 47\text{ }\mu\text{F MLCC}$

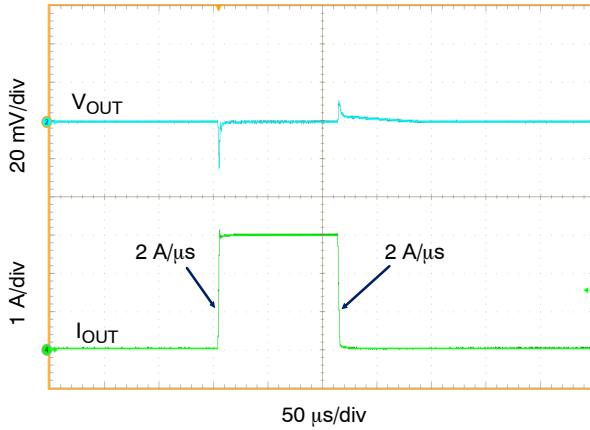

Figure 11. Load Transient Response,  $I_{OUT} = 10\text{ mA to }3\text{ A}$ ,  $C_{OUT} = 330\text{ }\mu\text{F Tantalum Polymer Cap} + 3 \times 10\text{ }\mu\text{F MLCC}$

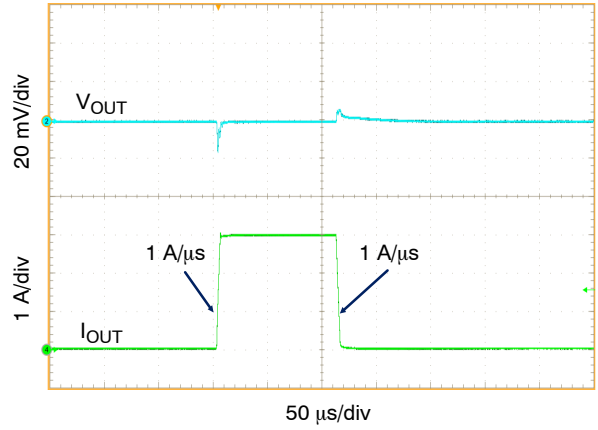

Figure 12. Load Transient Response,  $I_{OUT} = 10\text{ mA to }3\text{ A}$ ,  $C_{OUT} = 330\text{ }\mu\text{F Tantalum Polymer Cap} + 3 \times 10\text{ }\mu\text{F MLCC}$

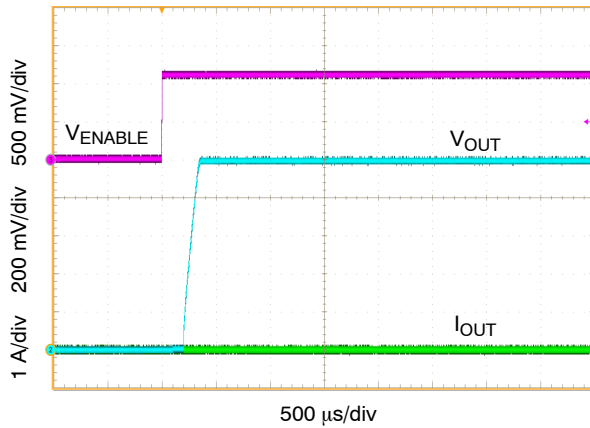

Figure 13. Enable Transient Response,  $I_{OUT} = 0\text{ A}$ ,  $C_{OUT} = 10\text{ }\mu\text{F MLCC}$ ,  $C_{SS} = 0\text{ nF}$

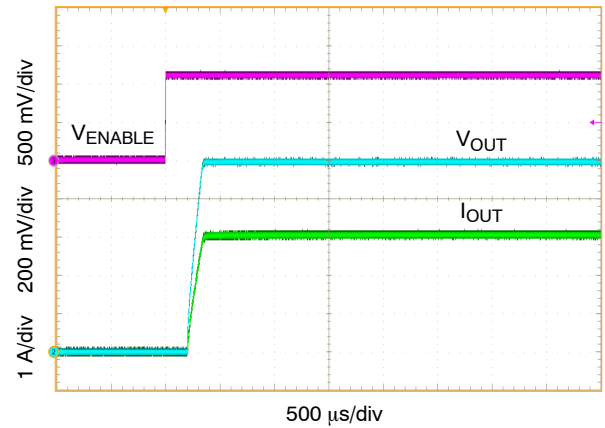

Figure 14. Enable Transient Response,  $I_{OUT} = 3\text{ A}$ ,  $C_{OUT} = 10\text{ }\mu\text{F MLCC}$ ,  $C_{SS} = 0\text{ nF}$

TYPICAL CHARACTERISTICS

At  $T_J = +25^\circ\text{C}$ ,  $V_{IN} = V_{OUT(NOM)} + 0.25\text{ V}$ ,  $V_{BIAS} = V_{OUT(NOM)} + 1.6\text{ V}$ ,  $V_{EN} = 1.1\text{ V}$ ,  $V_{OUT(NOM)} = 1.0\text{ V}$ ,  $C_{IN} = 10\text{ }\mu\text{F}$ ,  $C_{BIAS} = 1\text{ }\mu\text{F}$ , and  $C_{OUT} = 10\text{ }\mu\text{F}$  (effective capacitance value), unless otherwise noted.

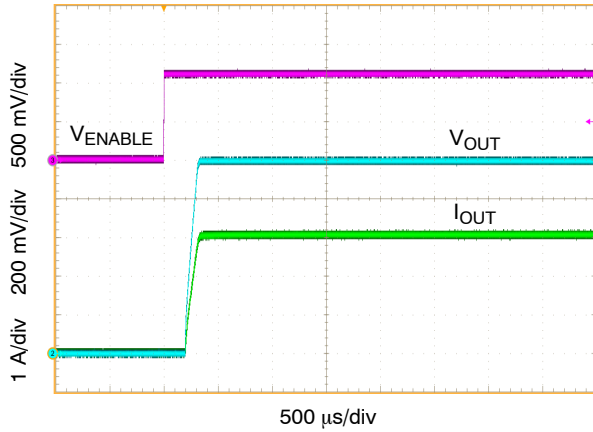

Figure 15. Enable Transient Response,  $I_{OUT} = 3\text{ A}$ ,  $C_{OUT} = 47\text{ }\mu\text{F MLCC}$ ,  $C_{SS} = 0\text{ nF}$

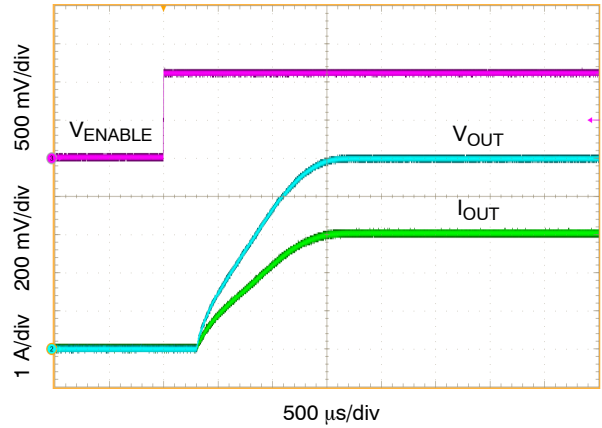

Figure 16. Enable Transient Response,  $I_{OUT} = 3\text{ A}$ ,  $C_{OUT} = 330\text{ }\mu\text{F Tantalum Polymer Cap} + 3 \times 10\text{ }\mu\text{F MLCC}$ ,  $C_{SS} = 10\text{ nF}$

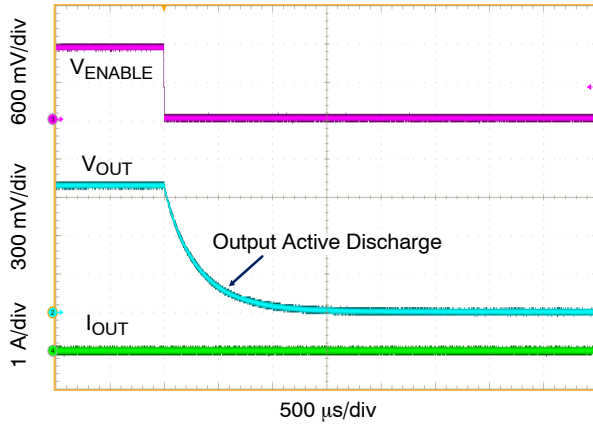

Figure 17. Enable Transient Response,  $I_{OUT} = 0\text{ A}$ ,  $C_{OUT} = 47\text{ }\mu\text{F MLCC}$ ,  $C_{SS} = 0\text{ nF}$

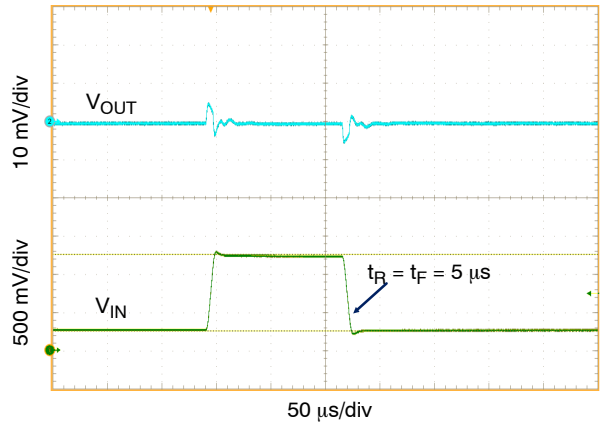

Figure 18.  $V_{IN}$  Line Transient Response,  $V_{IN} = 1.25\text{ V to } 2.25\text{ V}$ ,  $I_{OUT} = 0\text{ mA}$ ,  $C_{IN} = 0$ ,  $C_{OUT} = 10\text{ }\mu\text{F MLCC}$

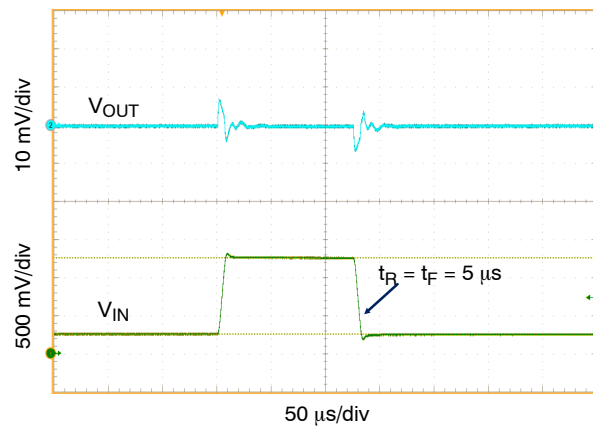

Figure 19.  $V_{IN}$  Line Transient Response,  $V_{IN} = 1.25\text{ V to } 2.25\text{ V}$ ,  $I_{OUT} = 3\text{ A}$ ,  $C_{IN} = 0$ ,  $C_{OUT} = 10\text{ }\mu\text{F MLCC}$

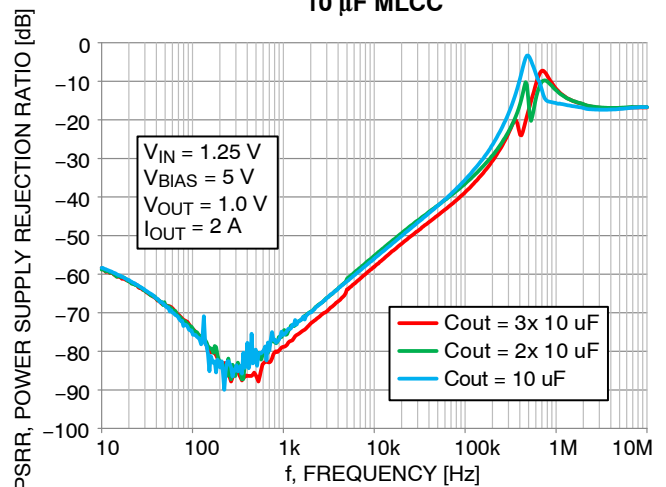

Figure 20.  $V_{IN}$  Power Supply Rejection Ratio vs. Frequency

TYPICAL CHARACTERISTICS

At  $T_J = +25^\circ\text{C}$ ,  $V_{IN} = V_{OUT(NOM)} + 0.25\text{ V}$ ,  $V_{BIAS} = V_{OUT(NOM)} + 1.6\text{ V}$ ,  $V_{EN} = 1.1\text{ V}$ ,  $V_{OUT(NOM)} = 1.0\text{ V}$ ,  $C_{IN} = 10\text{ }\mu\text{F}$ ,  $C_{BIAS} = 1\text{ }\mu\text{F}$ , and  $C_{OUT} = 10\text{ }\mu\text{F}$  (effective capacitance value), unless otherwise noted.

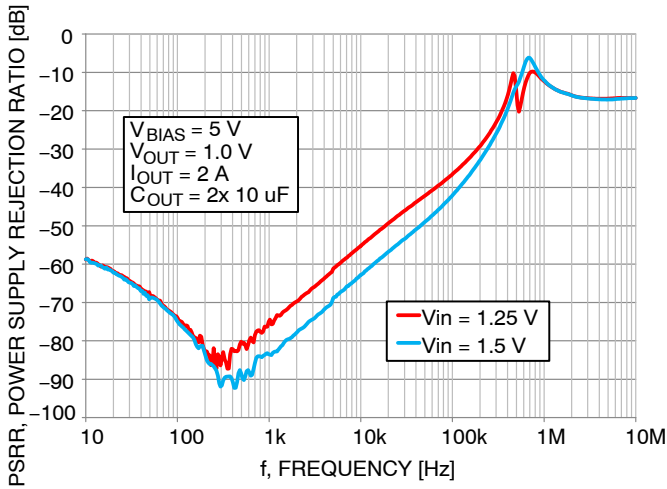

Figure 21.  $V_{IN}$  Power Supply Rejection Ratio vs. Frequency

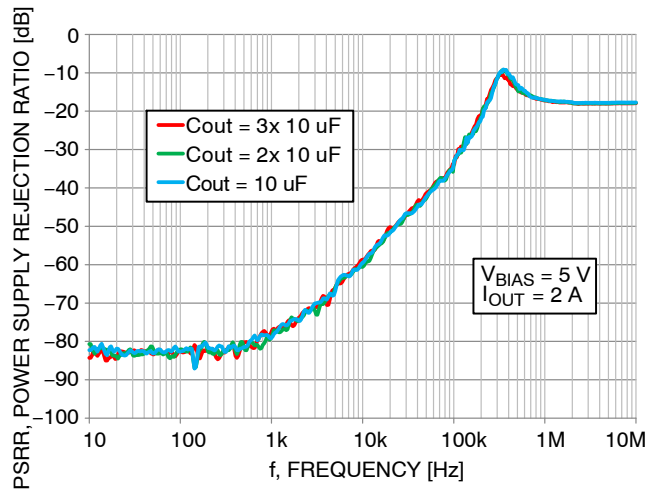

Figure 22.  $V_{BIAS}$  Power Supply Rejection Ratio vs. Frequency

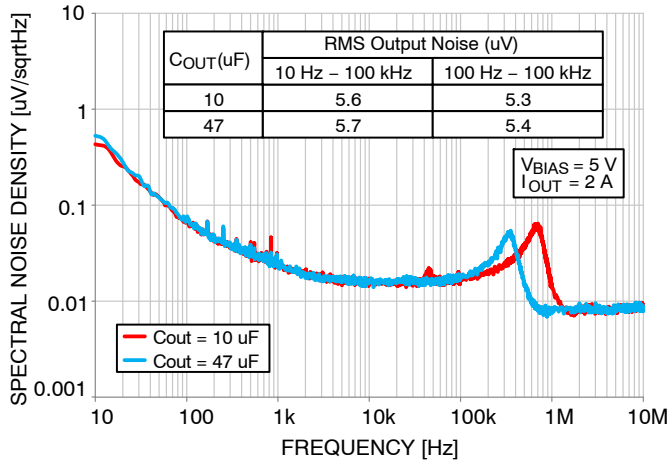

Figure 23. Output Voltage Noise Spectral Density



APPLICATIONS INFORMATION

The NCV59745 very low dropout low noise dual-rail voltage regulator is using NMOS pass transistor for output voltage regulation from  $V_{IN}$  voltage. All the low current internal control circuitry is powered from the  $V_{BIAS}$  voltage.

The use of an NMOS pass transistor offers several advantages in applications. Unlike a PMOS topology devices, the output capacitor has reduced impact on loop stability.  $V_{IN}$  to  $V_{OUT}$  operating voltage difference can be very low compared with standard PMOS regulators in very low  $V_{in}$  applications.

The NCV59745 offers programmable smooth monotonic start-up. The controlled voltage rising limits the inrush current what is advantageous in applications with large capacitive loads. The Voltage Controlled Soft Start time is programmable by external  $C_{SS}$  capacitor value.

The Enable (EN) input is equipped with internal hysteresis and deglitch filter.

Open Drain type Power Good (PG) output is available for  $V_{out}$  monitoring and sequencing of other devices.

NCV59745 is a Fixed Voltage linear regulator.

**Dropout Voltage**

Because of two power supply inputs  $V_{IN}$  and  $V_{BIAS}$  and one  $V_{OUT}$  regulator output, there are two Dropout voltages specified.

The first, the  $V_{IN}$  Dropout voltage is the voltage difference ( $V_{IN} - V_{OUT}$ ) when  $V_{OUT}$  starts to decrease by percents specified in the Electrical Characteristics table.  $V_{BIAS}$  is high enough, specific value is published in the Electrical Characteristics table.

The second,  $V_{BIAS}$  dropout voltage is the voltage difference ( $V_{BIAS} - V_{OUT}$ ) when  $V_{IN}$  and  $V_{BIAS}$  pins are joined together and  $V_{OUT}$  starts to decrease.

**Input and Output Capacitors**

The device is designed to be stable for ceramic output capacitors with effective capacitance in the range from 10  $\mu F$  up to 1000  $\mu F$ . The device is also stable with multiple capacitors in parallel.

In applications where no low input supply impedance is available (PCB inductance in  $V_{IN}$  and/or  $V_{BIAS}$  inputs as an example) the recommended  $C_{BIAS} \geq 1 \mu F$  and  $C_{IN} \geq 4.7 \mu F$  of effective capacitance value. For the best performance all capacitors should be connected to the NCV59745 respective pins directly in the device PCB copper layer, not through vias having not negligible impedance.

**Enable Operation**

The enable pin will turn the regulator on or off. The threshold limits are covered in the electrical characteristics table in this data sheet. To get the full functionality of Soft Start, it is recommended to turn on the  $V_{IN}$  and  $V_{BIAS}$  supply voltages first and activate the Enable pin no sooner than  $V_{IN}$  and  $V_{BIAS}$  are on their nominal levels. If the enable function is not to be used then the pin should be connected to  $V_{IN}$  or  $V_{BIAS}$ .

**Programmable Soft-Start**

The Soft-Start time is programmable by external  $C_{SS}$  capacitor value. If  $C_{SS}$  capacitor not used, the device is starting with Minimum Start-up time specified in the Electrical Characteristics table.

The output voltage ramping time during Soft-Start depends on the Soft-Start charging current  $I_{SS}$  and Soft-Start capacitor value  $C_{SS}$ .

The Soft-Start time can be calculated using following equation:

$$t_{SS} = C_{SS} \times 0.13$$

where

$t_{SS}$  = Soft-Start time in milliseconds

$C_{SS}$  = Soft-Start capacitor value in nano Farads

Soft-Start time vs  $C_{SS}$  capacitor value examples can be found in the Table 6. The maximal recommended value of  $C_{SS}$  capacitor is 1  $\mu F$ .

Unlike other LDO devices with external Noise Reduction / Soft-Start capacitor, the  $C_{SS}$  capacitor value has no connection with NCV59745 noise performance. After the Soft-Start phase the SS pin voltage persists in ramping up to the  $V_{BIAS}$  supply level.

**Table 6. CAPACITOR VALUES FOR PROGRAMMING THE SOFT-START TIME**

C <sub>SS</sub>	Soft-Start Time
Open	0.35 ms
4.7 nF	0.6 ms
10 nF	1.3 ms
47 nF	6 ms
100 nF	13 ms

**Output Noise**

Internal Noise Reduction filter is implemented to reduce the output voltage noise. Unlike LDO devices with external noise reduction capacitor this solution is not sensitive to the external capacitor quality.

**Output Active Discharge**

The NCV59745A option devices are equipped with Output Active Discharge feature. When EN input level is Low and/or Thermal Shutdown is active, the Output Active Discharge transistor is On and the output voltage node  $V_{OUT}$  is pulled down to GND through a 600  $\Omega$  resistor. The  $C_{OUT}$  output capacitor is discharged what is advantageous for applications requiring next  $V_{OUT}$  Start-Up ramping from 0 V.

**Power Good**

Power-Good (PG) is an open-drain, logic active-high output that indicates the status of the Output Voltage  $V_{OUT}$ . When  $V_{OUT}$  exceeds the PG trip threshold, the PG pin goes into a high-impedance state. When  $V_{OUT}$  is below this

## NCV59745

threshold the pin is driven to a low-impedance state pulling the PG pin to GND. An external pull-up resistor from 10 k $\Omega$  to 100 k $\Omega$  should be connected from this pin to a supply up to 5.5 V. The supply voltage can be higher than the input voltage. Alternatively, the PG pin can be left floating if output monitoring is not necessary.

### Current Limitation

The internal Current Limitation circuitry allows the device to supply the full nominal current and surges but protects the device against Current Overload or Short.

### Thermal Protection

Internal thermal shutdown (TSD) circuitry is provided to protect the integrated circuit in the event that the maximum

junction temperature is exceeded. When TSD activated, the regulator output turns off. When cooling down under the low temperature threshold, device output is activated again. This TSD feature is provided to prevent failures from accidental overheating.

### Power Dissipation

The maximum power dissipation supported by the device is dependent upon board design and layout. Mounting pad configuration on the PCB, the board material, and the ambient temperature affect the rate of junction temperature rise for the part. For reliable operation junction temperature should be limited to +125°C.

**Table 7. ORDERING INFORMATION**

Device	Output Current	Output Voltage	Option	Marking	Wettable Flank	Package	Shipping†
NCV59745AMW100TAG	3.0 A	1.00 V	Output Active Discharge	59745 V100A	SLP Step cut	QFNW20 (Pb-Free)	3000 / Tape & Reel
NCV59745AMW1015TAG	3.0 A	1.015 V	Output Active Discharge	59745 V1015A	SLP Step cut	QFNW20 (Pb-Free)	3000 / Tape & Reel
NCV59745AMW180TAG	3.0 A	1.80 V	Output Active Discharge	59745 V180A	SLP Step cut	QFNW20 (Pb-Free)	3000 / Tape & Reel
NCV59745AMW250TAG	3.0 A	2.50 V	Output Active Discharge	59745 V250A	SLP Step cut	QFNW20 (Pb-Free)	3000 / Tape & Reel

†For information on tape and reel specifications, including part orientation and tape sizes, please refer to our Tape and Reel Packaging Specifications Brochure, BRD8011/D.

# MECHANICAL CASE OUTLINE PACKAGE DIMENSIONS

ON Semiconductor®

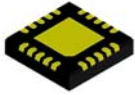

## QFNW20 4x4, 0.5P CASE 484AP ISSUE A

DATE 03 JUL 2018

NOTES:

1. DIMENSIONING AND TOLERANCING PER ASME Y14.5M, 1994.
2. CONTROLLING DIMENSION: MILLIMETERS
3. DIMENSION b APPLIES TO THE PLATED TERMINAL AND IS MEASURED BETWEEN 0.15 AND 0.30 FROM THE TERMINAL TIP.
4. COPLANARITY APPLIES TO THE EXPOSED PAD AS WELL AS THE TERMINALS.

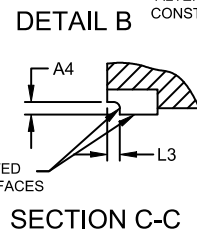
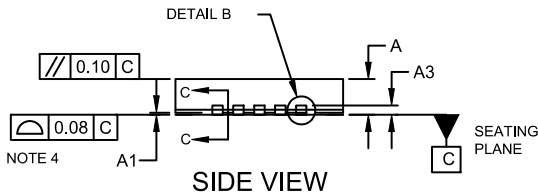
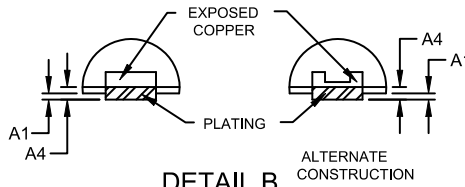
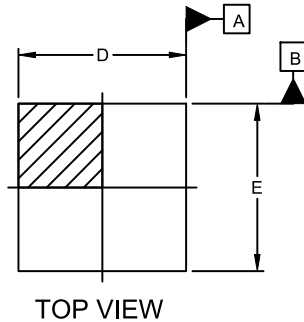

DIM	MILLIMETERS		
	MIN.	NOM.	MAX.
A	0.80	0.85	0.90
A1	---	---	0.05
A3	0.20 REF		
A4	0.10	---	---
b	0.20	0.25	0.30
D	3.90	4.00	4.10
D2	2.10	2.20	2.30
E	3.90	4.00	4.10
E2	2.10	2.20	2.30
e	0.50 BSC		
k	0.50 REF		
L	0.30	0.40	0.50
L3	0.05 REF		

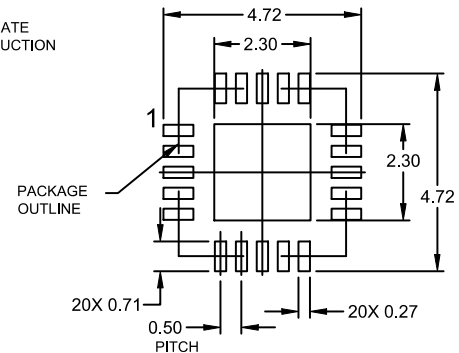
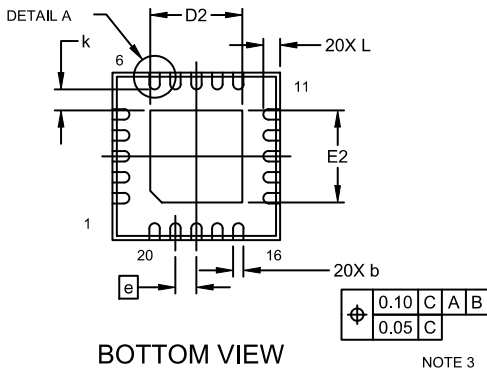
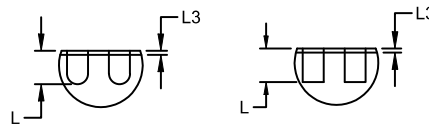

### GENERIC MARKING DIAGRAM\*

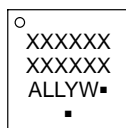

- XXXXXX= Specific Device Code
- A = Assembly Location
- LL = Wafer Lot
- Y = Year
- W = Work Week
- = Pb-Free Package

\*This information is generic. Please refer to device data sheet for actual part marking.  
Pb-Free indicator, "C" or microdot "▪", may or may not be present.  
(Note: Microdot may be in either location)

<b>DOCUMENT NUMBER:</b>	<b>98AON91716G</b>	Electronic versions are uncontrolled except when accessed directly from the Document Repository. Printed versions are uncontrolled except when stamped "CONTROLLED COPY" in red.
<b>DESCRIPTION:</b>	<b>QFNW20 4x4, 0.5P</b>	<b>PAGE 1 OF 1</b>

ON Semiconductor and are trademarks of Semiconductor Components Industries, LLC dba ON Semiconductor or its subsidiaries in the United States and/or other countries. ON Semiconductor reserves the right to make changes without further notice to any products herein. ON Semiconductor makes no warranty, representation or guarantee regarding the suitability of its products for any particular purpose, nor does ON Semiconductor assume any liability arising out of the application or use of any product or circuit, and specifically disclaims any and all liability, including without limitation special, consequential or incidental damages. ON Semiconductor does not convey any license under its patent rights nor the rights of others.

ON Semiconductor and  are trademarks of Semiconductor Components Industries, LLC dba ON Semiconductor or its subsidiaries in the United States and/or other countries. ON Semiconductor owns the rights to a number of patents, trademarks, copyrights, trade secrets, and other intellectual property. A listing of ON Semiconductor's product/patent coverage may be accessed at [www.onsemi.com/site/pdf/Patent-Marking.pdf](http://www.onsemi.com/site/pdf/Patent-Marking.pdf). ON Semiconductor reserves the right to make changes without further notice to any products herein. ON Semiconductor makes no warranty, representation or guarantee regarding the suitability of its products for any particular purpose, nor does ON Semiconductor assume any liability arising out of the application or use of any product or circuit, and specifically disclaims any and all liability, including without limitation special, consequential or incidental damages. Buyer is responsible for its products and applications using ON Semiconductor products, including compliance with all laws, regulations and safety requirements or standards, regardless of any support or applications information provided by ON Semiconductor. "Typical" parameters which may be provided in ON Semiconductor data sheets and/or specifications can and do vary in different applications and actual performance may vary over time. All operating parameters, including "Typicals" must be validated for each customer application by customer's technical experts. ON Semiconductor does not convey any license under its patent rights nor the rights of others. ON Semiconductor products are not designed, intended, or authorized for use as a critical component in life support systems or any FDA Class 3 medical devices or medical devices with a same or similar classification in a foreign jurisdiction or any devices intended for implantation in the human body. Should Buyer purchase or use ON Semiconductor products for any such unintended or unauthorized application, Buyer shall indemnify and hold ON Semiconductor and its officers, employees, subsidiaries, affiliates, and distributors harmless against all claims, costs, damages, and expenses, and reasonable attorney fees arising out of, directly or indirectly, any claim of personal injury or death associated with such unintended or unauthorized use, even if such claim alleges that ON Semiconductor was negligent regarding the design or manufacture of the part. ON Semiconductor is an Equal Opportunity/Affirmative Action Employer. This literature is subject to all applicable copyright laws and is not for resale in any manner.

## PUBLICATION ORDERING INFORMATION

### LITERATURE FULFILLMENT:

Email Requests to: [orderlit@onsemi.com](mailto:orderlit@onsemi.com)

ON Semiconductor Website: [www.onsemi.com](http://www.onsemi.com)

### TECHNICAL SUPPORT

North American Technical Support:  
Voice Mail: 1 800-282-9855 Toll Free USA/Canada  
Phone: 011 421 33 790 2910

### Europe, Middle East and Africa Technical Support:

Phone: 00421 33 790 2910

For additional information, please contact your local Sales Representative